

MV02

Snímač průtoku MV02 Sensor MV02

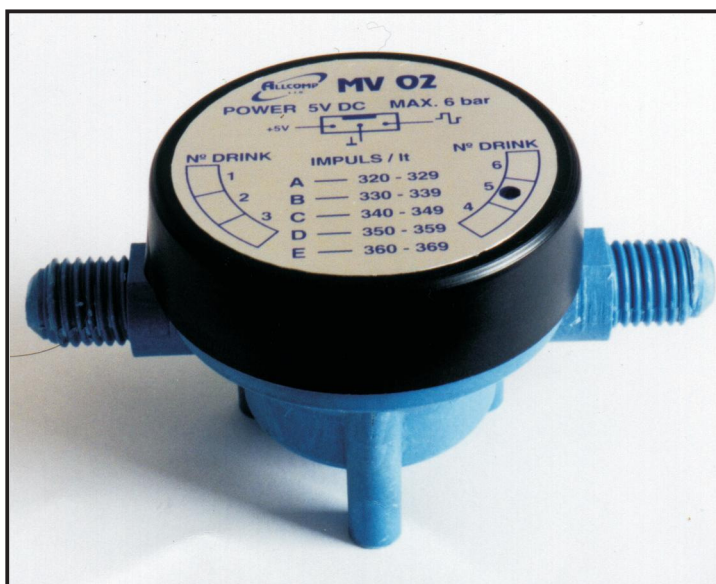

Snímač průtoku kapalin.

Doporučen pro použití na všechny druhy potravinářské tekutiny (limonády, pivo, voda, soda, víno atd. ...)

Sensor for measuring and recording of beverage mass.

Recommended for all beverage types (e.g. soda, water, beer, wine, juice etc. ...)

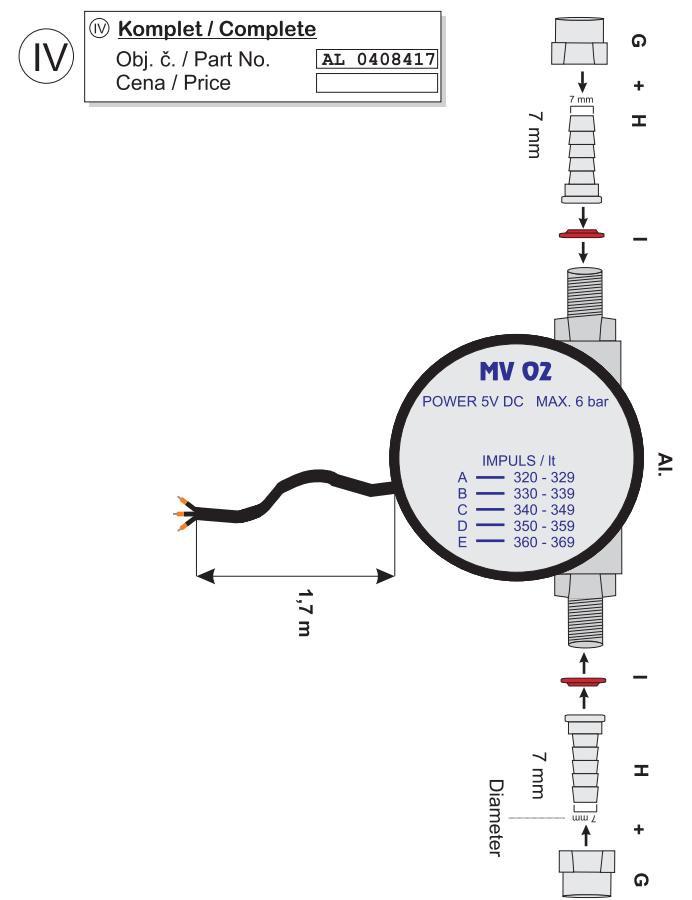
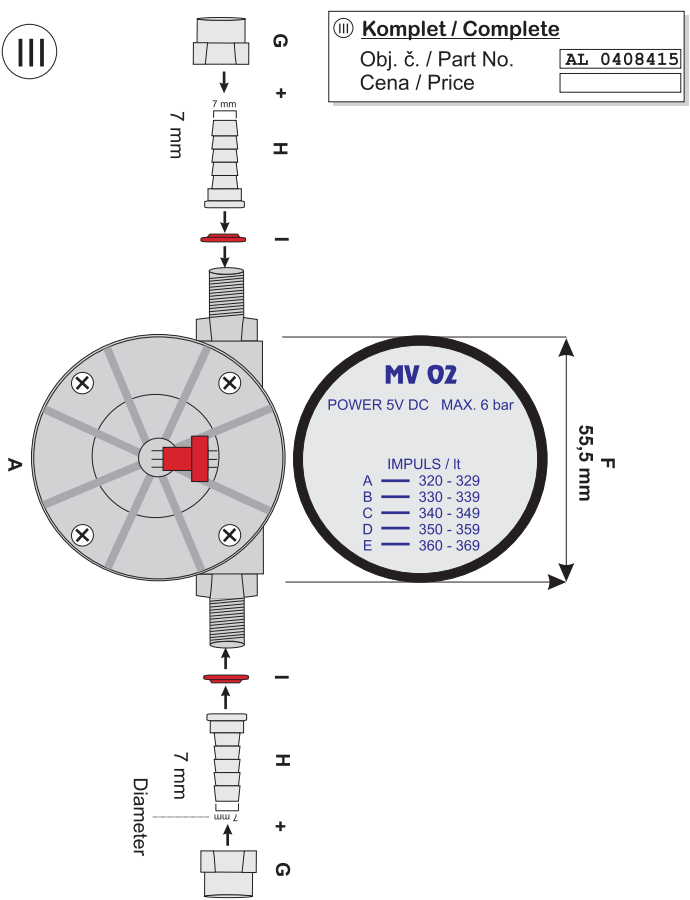
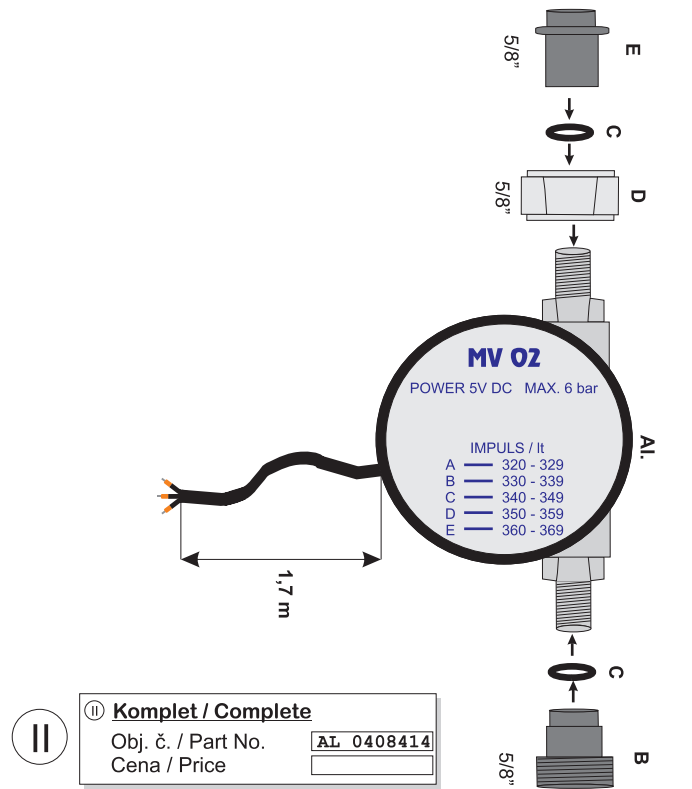
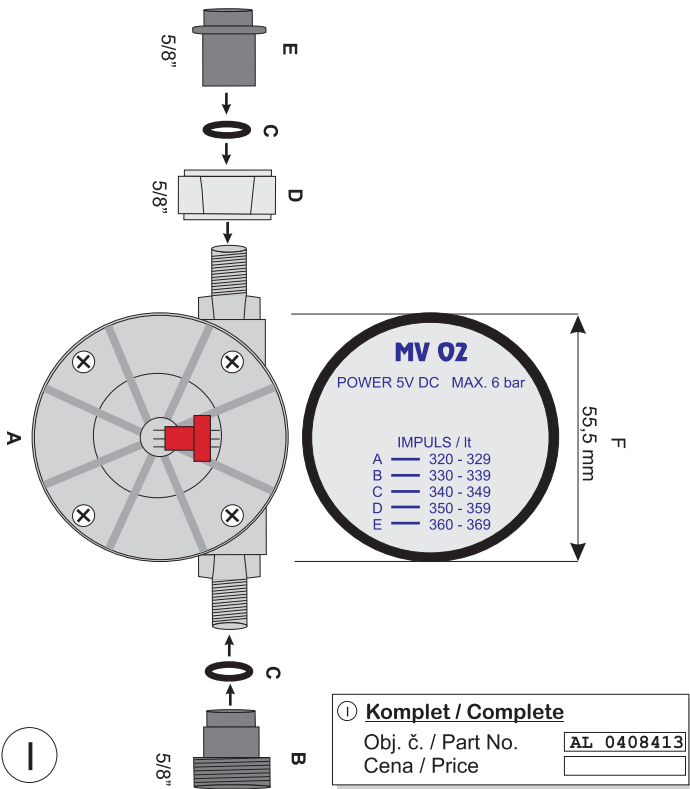

MV02

Komplety Completes

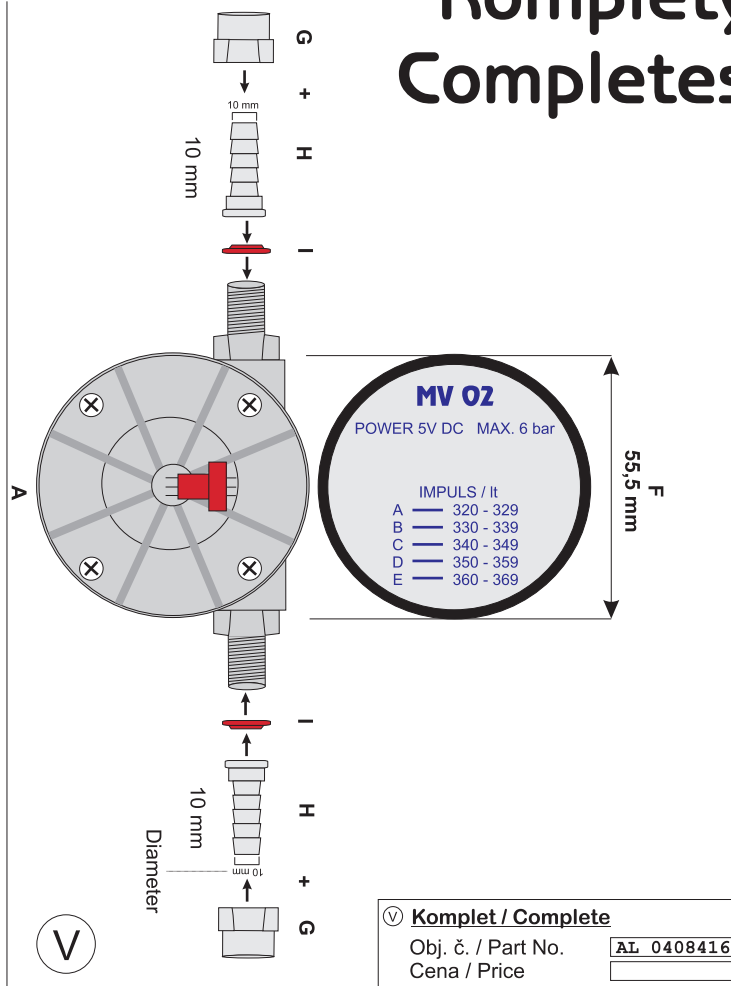
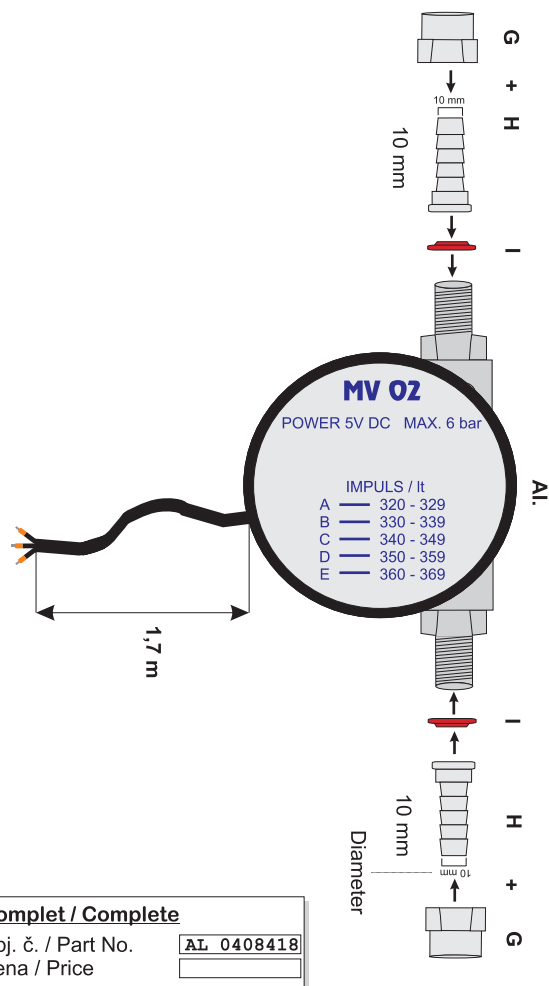



Obsahy kompletů Complete contains

| Komplet č. Complete No. | Obj. číslo Part No. | Obsah Contains |
|----------------------------|------------------------|---|
| VI | AL 0408418 | Snímač / Sensor Plastové šroubení vnitřní a vnější 5/8" / Plastic crew-coupling inside and outside 5/8" 2 x O krou ek / 2 x O ring Nerez pivní matice 5/8" / Stainless beer nut 5/8" Víčko / Lid |
| V | AL 0408416 | Snímač s kabelem a víčkem / Sensor with cable and lid Plastové šroubení vnitřní a vnější 5/8" / Plastic crew-coupling inside and outside 5/8" 2 x O krou ek / 2 x O ring Nerez pivní matice 5/8" / Stainless beer nut 5/8" |
| III | AL 0408415 | Snímač / Sensor 2 x šroubení na hadici 7mm / 2 pipeline cerwing 7mm 2 x těsnění / 2 x gaskefs Víčko / Lid |
| IV | AL 0408417 | Snímač / Sensor 2 x šroubení na hadici 7mm / 2 pipeline cerwing 7mm 2 x těsnění / 2 x gaskefs |
| V | AL 0408416 | Snímač / Sensor 2 x šroubení na hadici 10mm / 2 pipeline cerwing 10mm 2 x těsnění / 2 x gaskefs Víčko / Lid |
| VI | AL 0408418 | Snímač / Sensor 2 x šroubení na hadici 10mm / 2 pipeline cerwing 10mm 2 x těsnění / 2 x gaskefs |

Aktuální ceník přilo en / Actual pricelist enclosed

Specifikace dílů snímače průtoku MV02

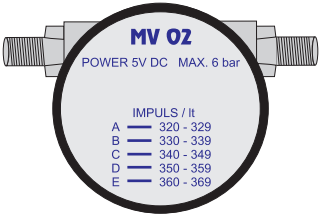
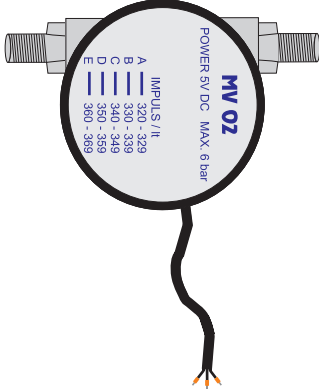
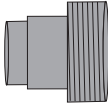

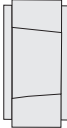
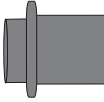
Parts sensor MV02 specification

| | Nákres Drawing | Název Type | Velikost Size | Obj. číslo Part No. | Cena/Kč Price/CZK |
|-----|---|--|--|------------------------|----------------------|
| A |  | Snímač s víčkem Sensor with lid | 45x95x55 (vxšxh mm) (hxwxd mm) | AL 0408400 | |
| Al. |  | Snímač (turbínka) s kabelem Sensor (turbine) with cable | 45x95x55 (vxšxh mm) (hxwxd mm) kabel 1,7 m cable 1,7 m | AL 0408412 | |
| B |  | Plastové šroubení vnější Plastic crew-coupling outside | 5/8" | AL 0408405 | |
| C |  | O krou ek O ring | | AL 0408408 | |
| D |  | Nerez pivní matice Stainless beer nut | 5/8" | AL 0408404 | |
| E |  | Plastové šroubení vnitřní Plastic crew-coupling inside | 5/8" | AL 0408406 | |

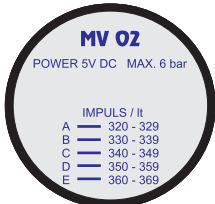
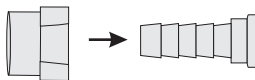

Aktuální ceník přiložen / Actual pricelist enclosed

Specifikace dílů snímače průtoku MV02

Parts sensor MV02 specification

| | Nákres Drawing | Název Type | Velikost Size | Obj. číslo Part No. | Cena/Kč Price/CZK |
|-------------|---|--|------------------|--------------------------|----------------------|
| F |  <p> MV 02 POWER 5V DC MAX. 6 bar IMPULS / lt A — 320 - 329 B — 330 - 339 C — 340 - 349 D — 350 - 359 E — 360 - 369 </p> | Víčko Lid | | AL 0408410 | |
| G + H |  | Šroubení na hadici Pipeline cerwing | 7 mm 10 mm | AL 0408401 AL 0408422 | |
| I |  | Těsnění Gaskef | | AL 0408402 | |

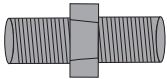
Doplňky Accessories

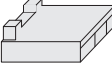
| | | | | |
|---|--|---------------|--------------------------|--|
|  | Plastová spojka Plastic connector | | AL 0408409 | |
|  | Spona Clamp | 7 mm 10 mm | AL 0408420 AL 0408421 | |
|  | Kabel VMS B + konektor Cable VMS B + connector Molex | cable 1,7m | AL 0408419 | |
|  | Molex konektor Molex connector | | AL 0408411 | |